

# AIPHONE



7-inch Touchscreen Intercom

# JP Series



# Large 7" Screen with

Providing a slim, low-profile design, the JP Series offers elegant styling and easy to use functionality.



**User-friendly touchscreen navigation**



**Wide-angle door camera allows greater viewing of a visitor**



**Expandable-station capacity up to 4 doors and 8 inside stations**



**Integrate-analog CCTV cameras or other security type devices for full functionality**

# Superior Image Quality



Actual size

7-inch Touchscreen Intercom

# JP Series



# Perfect system for small offices and as well as small to large home and

The JP Series of intercoms provide high quality functions for a diverse

## Example: Commercial Campus

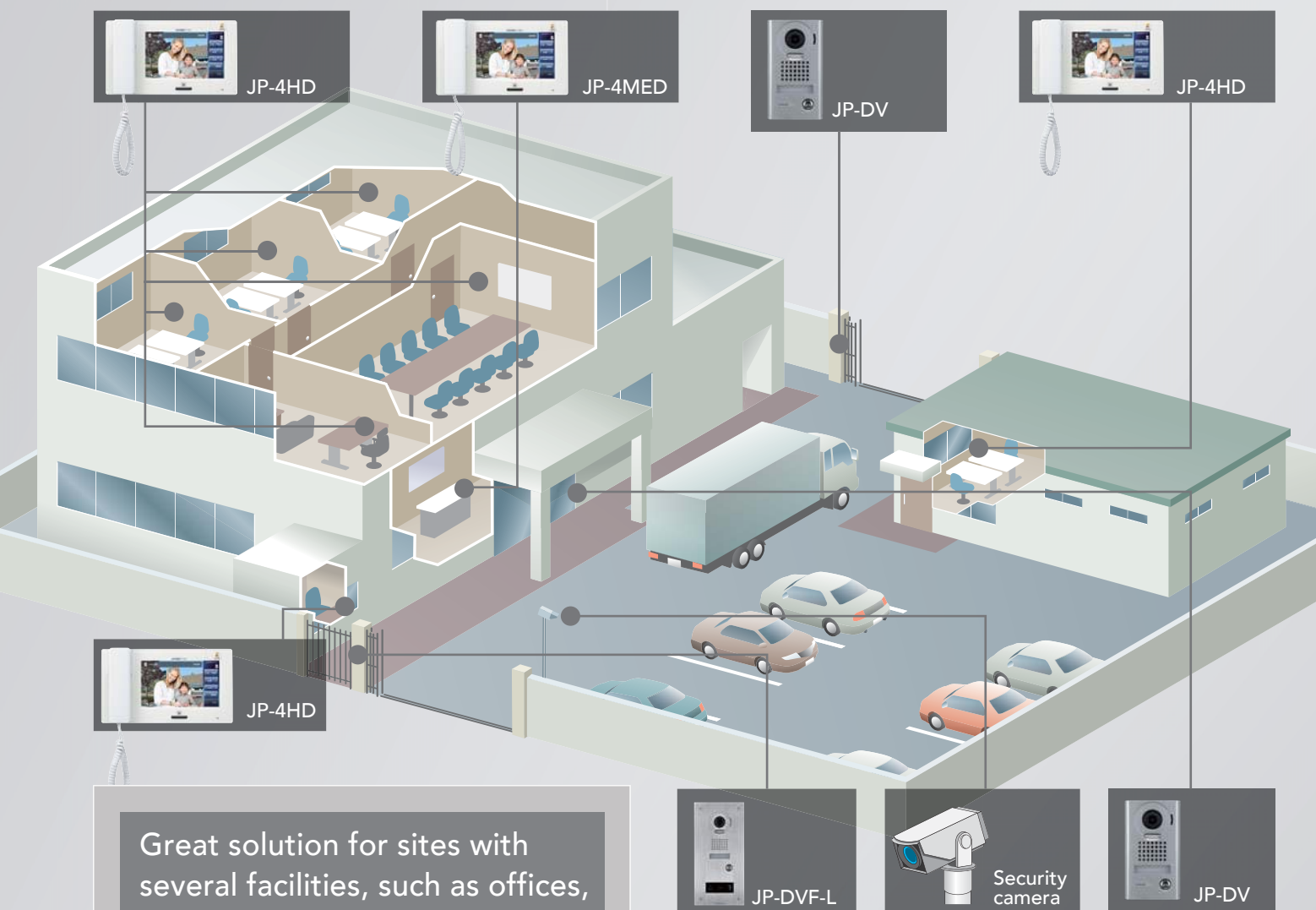

Great solution for sites with several facilities, such as offices, factories, and warehouses

The JP Series is the optimal intercom system for communication between areas at different locations on the same grounds. The also provides internal communication between different office buildings, main-gate security, CCTV surveillance rooms, and other locations.

### Other Recommended Installation Sites



Schools



Retail shops

# other commercial sites, residential locations

range of commercial applications, residential styles, and various applications.

## Example: Residential Dwelling

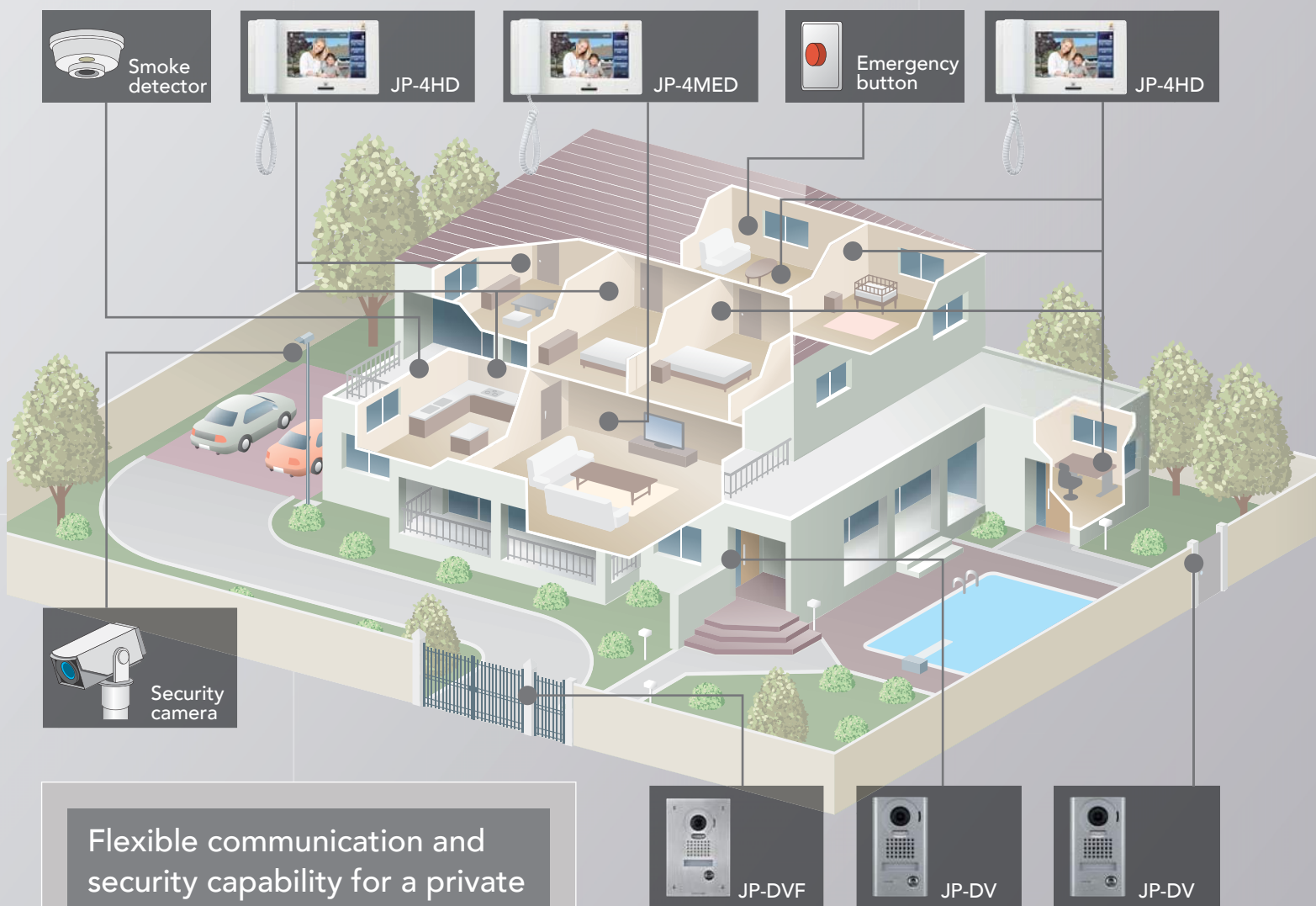

### Flexible communication and security capability for a private residence

The JP Series also provides internal communication and monitoring between all other stations with a push of a button. Greater security integrating a separate security camera, smoke detector or other prevention devices.

### Other Recommended Installation Sites



Small offices

# Large 7-inch screen displaying Sh



## Focus on a particular area for more detail

### Zoom

Using the touchscreen, zoom in on visitor faces and other specific areas.

[ Wide view ]



[ Zoom view ]



### PanTilt

Using the PanTilt function, view details such as ID badges or labels.

[ Zoom view ]



[ PanTilt view ]



# arp Video

## ■ LCD captures a wide view of the entrance area



The JP Series' 170° horizontal angle and 100° vertical angle camera minimizes blind spots, ensuring a clear view of the door station area.

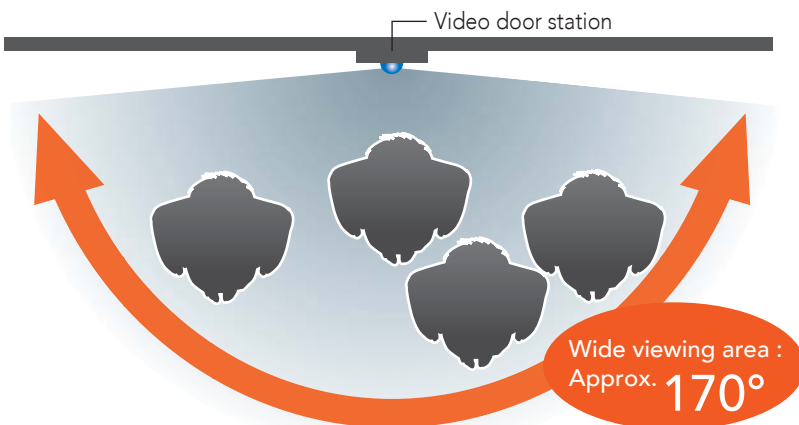

## ■ Coverless lenses on door stations reduce glare

High-durability lenses permit use even without a cover. This prevents glare from reflections of scattered light on the lens cover, and also reduces lens clouding from condensation.

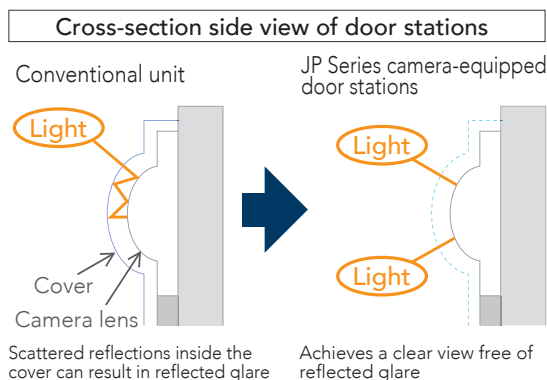

## ■ Door stations boasting an IK08 vandal-resistance rating



The JP Series' vandal-resistant door stations have an impact-resistance rating of IK08.

\*Vandal resistant video door stations:  
JP-DV, JP-DVF, JP-DVF-L

# Full functionality for a multitude



## ■ User-Friendly Touchscreen Navigation

Use the JP Series touchscreen to easily control all functions of the system.

Large buttons and intuitive icons allow for quick navigation and control.



## ■ Internal communication

### [ All call ]

Simultaneously make an announcement to all master stations.

### [ Individual call ]

Select a single master station to call.

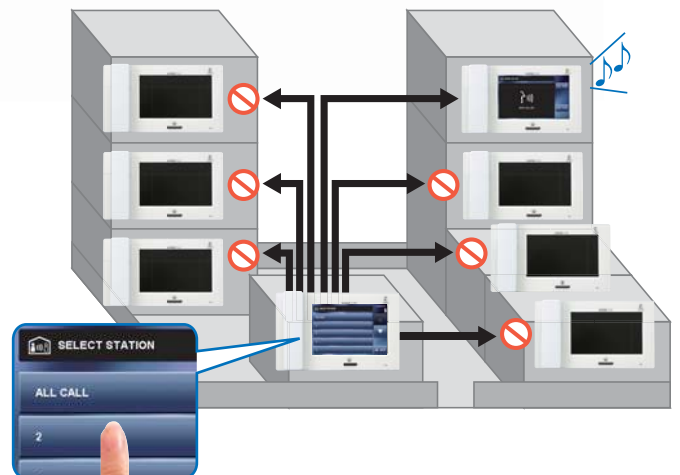
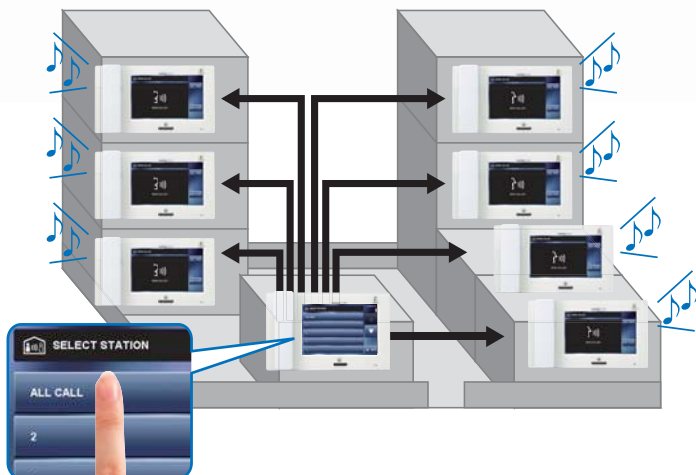



# of basic communication needs



## ■ Flexible communication – all-in-one device

### Hands-free (One Touch)

Simply touch the screen and easily communicate with visitors using the built-in microphone and speaker.



### Handset

Need privacy? Just pick up the handset at any time during conversation. It is perfect for high-noise areas!



## ■ Features for the visually and hearing Impaired

### Visual and Audio guides using select door stations

Simple audio and visual indicators help impaired visitors use the system. Cues guide visitors through call placement, communication, and access.



Audio guide

Visual guide

### T-Coil connection for hearing aids



The JP Series master station is equipped with T-coil support for T-coil-compatible hearing aids.

## ■ Audio monitoring of other master stations

Master stations can be set to monitor audio from other master stations. Quickly check in on family members.



## ■ Available in 9 languages

Choose from English, German, French, Italian, Spanish, Dutch, Norwegian, Traditional Chinese, or Simplified Chinese.

# Safety and Security

## Automatically record visitors who come to your door



### [ Built-in memory ]

After a call is placed, the JP Series records 6 pictures per call to internal memory.

6 pictures

3 pictures in Zoom mode



3 pictures in Wide mode



### [ SD card ]

If an SD / SDHC card (not included) is set as the primary storage location, recording frequency increases to 4 pictures per second for up to 10 seconds per call.

40 pictures

10 seconds (up to 40 pictures)

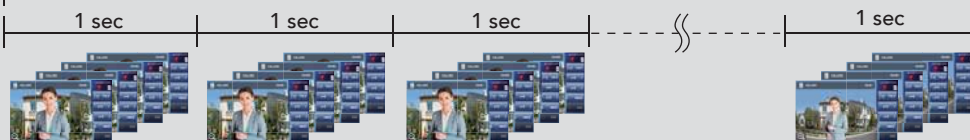

Record outside disturbances by pushing the manual record button.



Somebody you don't know? Record them in case something happens.

## See images clearly day and night

The JP Series is equipped with an advanced light adjustment feature to compensate for varying light levels. If a picture is too dark, use the ADJUST feature to increase brightness at the door station.

### Day time with strong backlight

Before

After



The image is simulated.

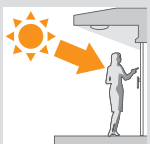

### Night time with low light

Before

After



The image is simulated.



# Features

## ■ Integrate with emergency buttons and sensors for heightened security in every situation

The JP Series can be combined with up to three optional input circuits, including emergency buttons, smoke detectors, and gas-leak alarms. The intercom system (master station) provides an audio and visual warning if a button is pressed or a sensor activated.

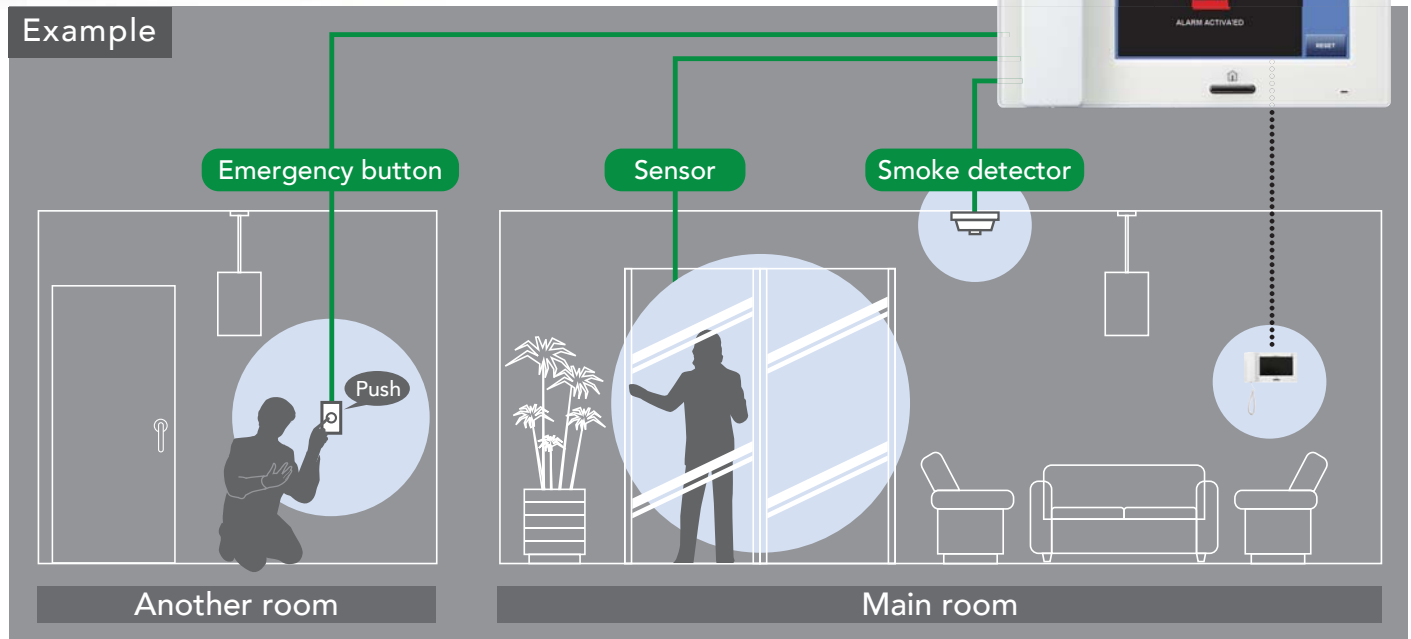

## ■ Add surveillance cameras for additional video viewing

Installing cameras makes it possible to view entranceways, garages, gates, and other outside areas on the intercom monitor. Redundant security through use of door station and CCTV can further boost performance as a protection system.

### Connect CCTV and Audio Door Station

See the surrounding area by connecting a security camera with the JPW-BA adaptor. The same adaptor allows for two way communication when a GT-D is added.

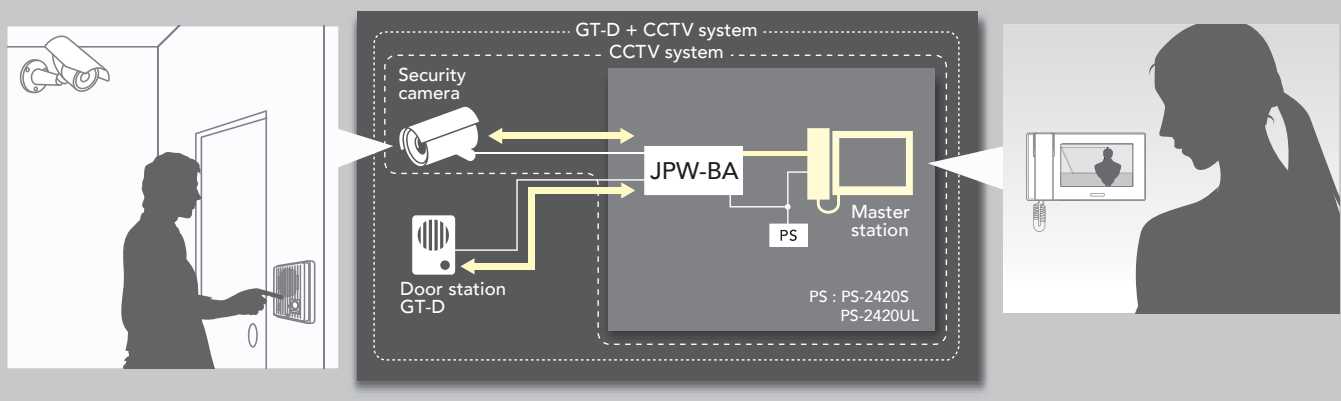

# Flexible wiring to accommodate a

The units wire using CAT-5e/6 cable, allowing for easy installation into new or retrofit projects.

Save money!! Install the JP Series using today's most readily available and dependable wiring method.



: Master station



: Sub master station



**PS24** : PS-2420S, PS-2420UL



: CAT-5e/6 (non-shielded)



: PE cable (2-conductor)

## Wiring distance between each device

	CAT-5e/6 (24AWG)	Wire diameter (PE cable)				Notes
		Ø0.65 mm (22 AWG)	Ø0.8 mm (20 AWG)	Ø1.0 mm (18 AWG)	Ø1.2 mm (16 AWG)	
[A]	30m (98')	-				When 3 room stations are powered by a single power supply
[B]	200m (650')	-				
[C]	50m (165')	-				When 2 room stations are powered by a single power supply
[D]	50m (165')	-				
[E]	-	50m (165')	100m (330')	100m (330')	100m (330')	
[F]	-	5m (16')	5m (16')	10m (33')	10m (33')	
[G]	-	5m (16')	10m (33')	10m (33')	10m (33')	
[H]	-	100m (330')	150m (490')	200m (650')	200m (650')	
[I]	-	50m (165')	75m (245')	100m (330')	100m (330')	



## Station-to-Station (Daisy-chain) Wiring

Directly connect a master station to a sub master station. This wiring style is perfect for projects where maximum distance is a concern.

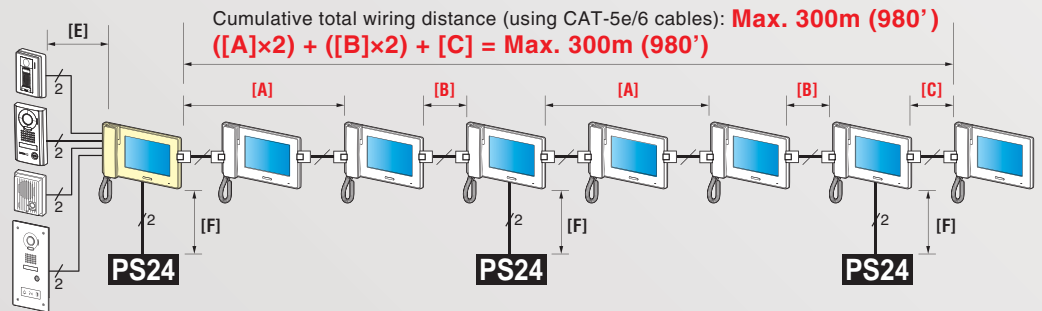

- [A], [C]: A single power supply can power up to 1 master and 2 sub master stations, or 3 sub master stations. The wiring distance varies depending on the number of powered room stations.
- See "Wiring distance between each device" above for the maximum distance between each device.



## Centralized (Home-run) Wiring

Connect master stations to a central wiring adaptor to simplify wiring over a widespread project.

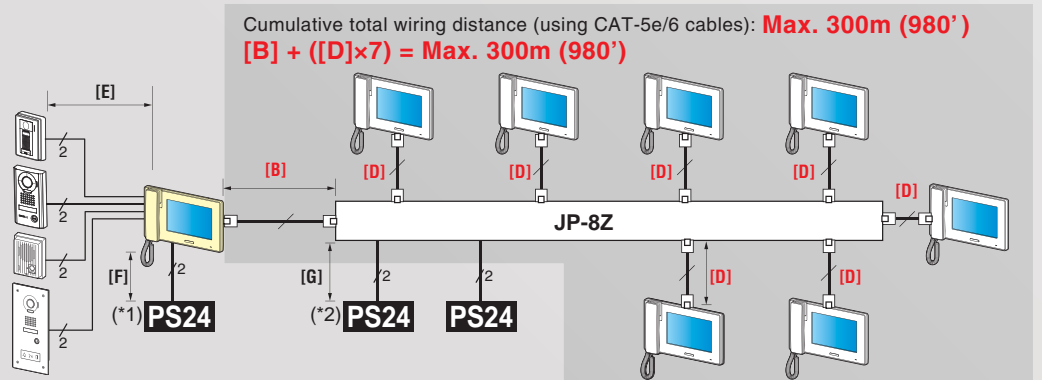

- (\*)1: The master station requires a power supply.
- (\*)2: Up to 4 sub master stations can be powered with one power supply. Use two power supplies for 5 - 7 sub master stations.
- See "Wiring distance between each device" above for the maximum distance between each device.

# broad range of applications



## Combined Wiring

Connect a system using both station-to-station and centralized wiring to meet the requirements of the project.

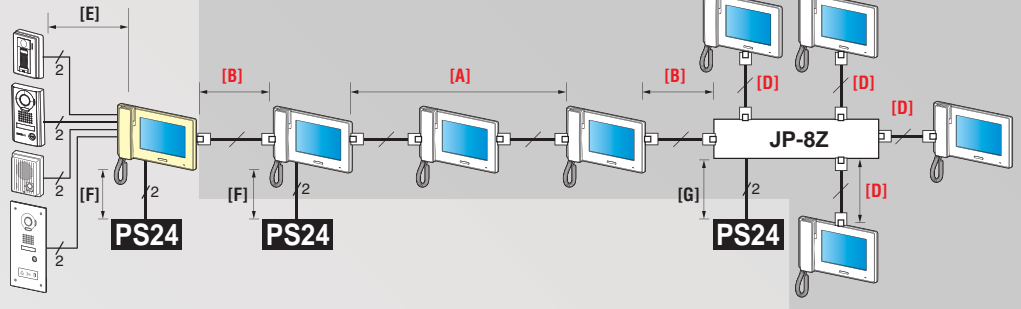

• See "Wiring distance between each device" at left for the maximum distance between each device.

## Long distance wiring and CCTV integration

With various wiring methods, family and property can remain secure even over long distances. Integrating CCTV cameras provides the consumer additional surveillance around the home or office.

Drastically extend the maximum distance between door and master stations.

Double the wiring distance between the door and master stations by using the JPW-BA adaptor. When used, the maximum distance can reach an amazing 600m!

### Extending the distance between door and master stations

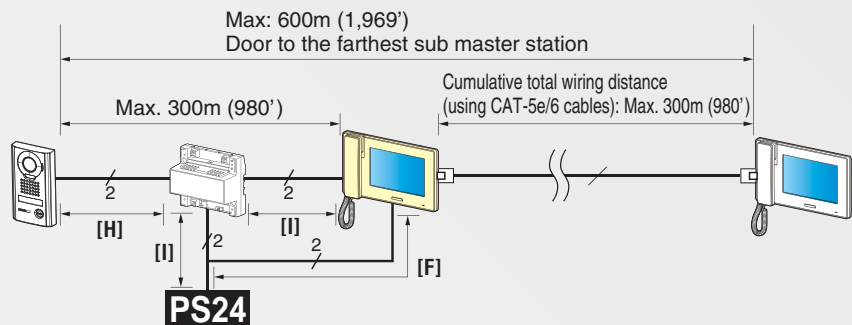

• See "Wiring distance between each device" at left for the maximum distance between each device.

### Connect CCTV and Audio Door Station

See the surrounding area by connecting a security camera using the JPW-BA adaptor. The same adaptor allows for two way communication when a GT-D is added.

### Connecting CCTV and audio door station (GT-D)

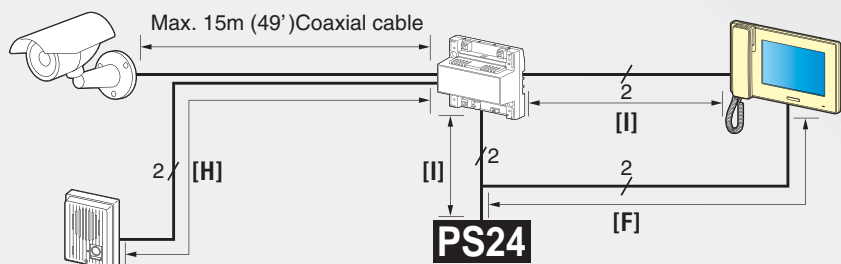

• See "Wiring distance between each device" at left for the maximum distance between each device.

# Components

## Master station



JP-4MED  
Hands-free color video intercom master station

## Sub master station



JP-4HD  
Hands-free color video intercom sub master station

## Boxed set



JPS-4AED : JP-4MED & JP-DA  
 JPS-4AEDV : JP-4MED & JP-DV  
 JPS-4AEDF : JP-4MED & JP-DVF  
 Add appropriate power supply

## Video door station



JP-DA  
PanTilt & Zoom video door station, surface mount



JP-DV  
PanTilt & Zoom vandal-resistant video door station, surface mount



JP-DVF  
PanTilt & Zoom vandal-resistant video door station, flush mount



JP-DVF-L  
PanTilt & Zoom vandal-resistant video door station, flush mount (Guidance-enabled type)

## Door station



GT-D  
Audio only door station



JPW-BA  
Long distance adaptor



JP-8Z  
Distribution adaptor



RY-3DL  
Multiple door release adaptor

## Power supply



PS-2420S, PS-2420UL  
24V DC Power supply

## Other



IER-2  
Call extension speaker



AC-10S  
Access control keypad, surface mount



JP-DV + AC-10S

## UNIT DIMENSIONS (mm)

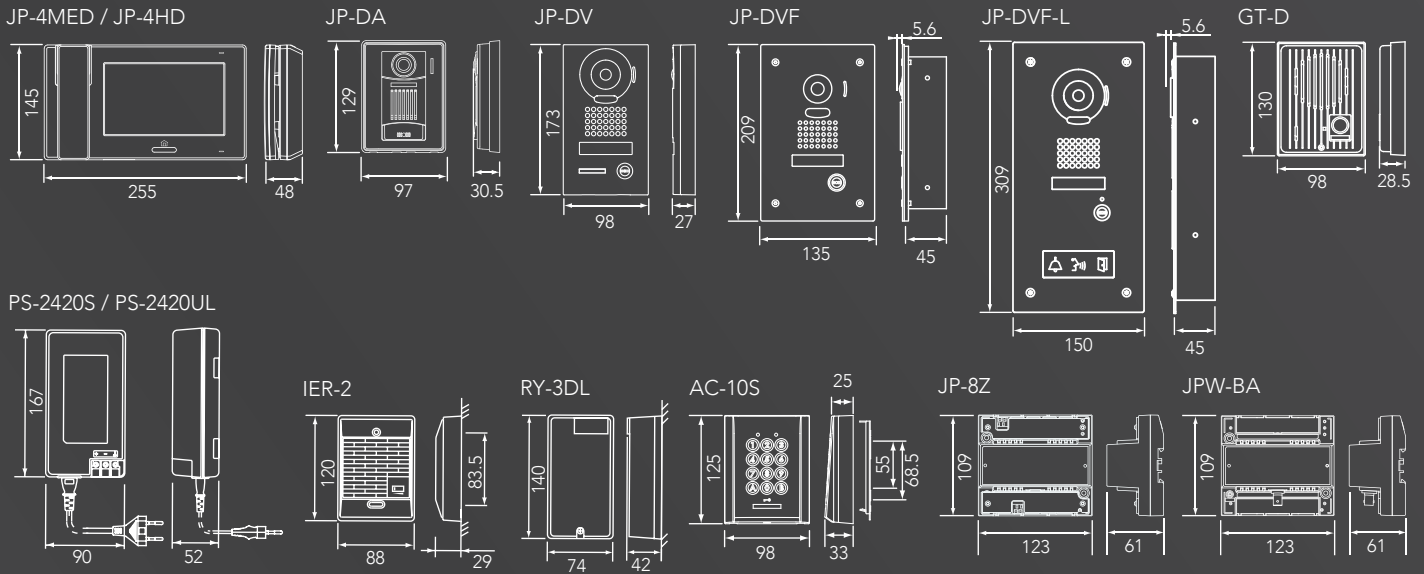

## CAMERA POSITION & IMAGE VIEW AREA

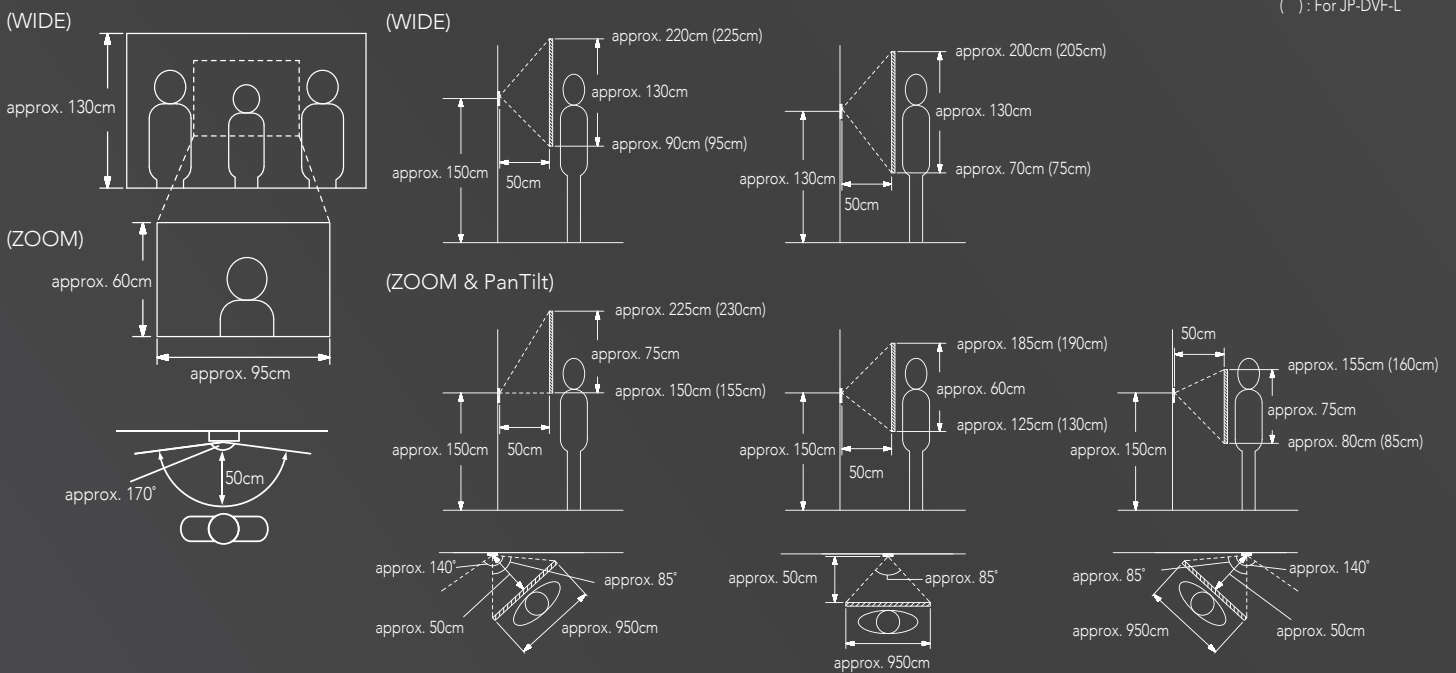

## SPECIFICATIONS

### Inside stations (JP-4MED / JP-4HD)

Power supply	DC 24V
Current consumption	JP-4MED:340mA / JP-4HD:200mA
Communication	Handset:Simultaneous communication Hands-free:Auto-voice actuation
Ambient temperature	0 - 40°C
Monitor	7 inch color LCD
Mounting	Wall-mount
Back box	3-gang box
Material	Flame resistant ABS resin
Color	White
Weight	JP-4MED:Approx. 790g / JP-4HD:Approx. 780g

### Door stations (JP-DA/JP-DV/JP-DVF/JP-DVF-L)

Operating temperature	-10 - 60°C
Weight	JP-DA:Approx. 170g
	JP-DV:Approx. 650g
	JP-DVF:Approx. 570g
	Flush mount back box:Approx. 450g
	JP-DVF-L:Approx. 980g Flush mount back box:Approx. 670g

### JPW-BA

Power supply	DC 24V
Current consumption	90mA
Operating temperature	0 - 40°C
Mounting	DIN rail
Weight	Approx. 200g

### JP-8Z

Power supply	DC 24V
Operating temperature	0 - 40°C
Mounting	DIN rail
Weight	Approx. 210g



Distributed by :



Deming Prize  
Deming Medal



**AIPHONE PTY LTD**  
Unite 11A, 2 Eden Park Drive  
Macquarie Park, NSW 2113  
Australia  
Tel.: 02-8036-4507  
URL: <http://www.aiphonepty.com.au/>

JP(AU)1412A

All rights reserved. The design and specifications are subject to change without notice for improvement.

Printed in Japan (AU)  
MA57045AJZ